

Linear

LINI-S R207 Fixture Guide

KKDÖ



Indoor | Surface | Dynamic output up to 1323lm/m (403lm/ft)



Key applications

- ✓ Architectural detail
- ✓ Cabinet & furniture
- ✓ Cove lighting
- ✓ Display case
- ✓ Indirect lighting
- ✓ Interior
- ✓ Mirror back lighting
- ✓ Retail display
- ✓ Shelving display
- ✓ Special effect

Key features

- ✓ Custom lengths
- ✓ Constant Voltage (CV)
- ✓ Diffusion: spotting
- ✓ Extensive CCT range
- ✓ IP40 dry area
- ✓ LEDmix dynamic white

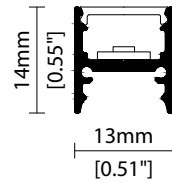

MOUNTING METHODS



KKCP-10 Concealed clip

Warm dim (Dynamic white)

Output Luminance %

min DIM1 Input Level max

— CH1 (Warmer)
— CH2 (Cooler)

LEDmix R207

CCT Selection 1 CCT Selection 2

LEDmix R209

CCT Selection 1 CCT Selection 2

LEDmix **warm dim** (Dynamic white) is a pre-programmed dimming curve setting enabling two different colour temperatures (CCTs) to blend harmoniously to achieve a warming lighting effect when dimmed.

KKDC LEDmix strips allow two separate CCT selections to be specified within the same PCB strip.

Use the table opposite to help determine which 2 CCT selections you require according to your preferred cool to warm dimming range.

**Note: The blended CCT is approx. 'cool-end' result at 100% brightness based on using the KKDC LED CCT specification.*

CCT Selection 1	CCT Selection 2	
	Blended CCT*	PCB CCT
1900K~	2000K 2100K 2200K 2300K 2500K 2600K 2700K 3000K 3500K	2100K PCB 2300K PCB 2500K PCB 2700K PCB 3000K PCB 3200K PCB 3500K PCB 4000K PCB 5000K PCB
2100K~	2200K 2300K 2400K 2600K 2700K 2800K 3000K 3600K	2300K PCB 2500K PCB 2700K PCB 3000K PCB 3200K PCB 3500K PCB 4000K PCB 5000K PCB
2300K~	2400K 2500K 2700K 2800K 2900K 3100K 3700K	2500K PCB 2700K PCB 3000K PCB 3200K PCB 3500K PCB 4000K PCB 5000K PCB
2500K~	2600K 2800K 2800K 3000K 3200K 3800K	2700K PCB 3000K PCB 3200K PCB 3500K PCB 4000K PCB 5000K PCB
2700K~	2900K 3000K 3100K 3400K 3900K	3000K PCB 3200K PCB 3500K PCB 4000K PCB 5000K PCB
3000K~	3100K 3300K 3500K 4000K	3200K PCB 3500K PCB 4000K PCB 5000K PCB
3200K~	3300K 3600K 4100K	3500K PCB 4000K PCB 5000K PCB
3500K~	3700K 4300K	4000K PCB 5000K PCB
4000K~	5100K	5000K PCB

Tuneable white

Channel Mix Ratio %

min DIM1 Input Level max

— CH1 (Warmer)
— CH2 (Cooler)

LEDmix R207

CCT Selection 1 CCT Selection 2

LEDmix R209

CCT Selection 1 CCT Selection 2

LEDmix **tunable white** enables two different LED colour temperatures (CCTs) to be specified within the same LEDmix strip.

Each CCT selection can then be independently controlled (via your dimming control system) to adjust the warm & cool light output (CCT selections) and thus tailor a blended light colour of your choosing.

CCT Selection 1	CCT Selection 2
1900K~	2100K 2300K 2500K 2700K 3000K 3200K 3500K 4000K 5000K
2100K~	2300K 2500K 2700K 3000K 3200K 3500K 4000K 5000K
2300K~	2500K 2700K 3000K 3200K 3500K 4000K 5000K
2500K~	2700K 3000K 3200K 3500K 4000K 5000K
2700K~	3000K 3200K 3500K 4000K 5000K
3000K~	3200K 3500K 4000K 5000K
3200K~	3500K 4000K 5000K
3500K~	4000K 5000K
4000K~	5000K

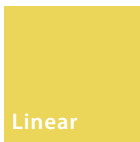

LINI-S R207

Specification sheet



Dimensions	H14/W13/L97-2014mm (H0.55/W0.51/L3.81-79.29in)
PCB Cut-point	83.3mm increment/2000mm max (3.28in increment/78.74in max)
LED Pitch	13.9mm-144LED/m (0.55in - 44LED/ft)
Chip	s-line k-line
Cover/Optics	Clear (105°)/Diffused (110°)
CCT	s-line: 1900K/2100K/2300K/2500K/2700K/3000K/3500K/4000K/5000K k-line: 1900K/2100K/2300K/2500K/2700K/3000K/3500K/4000K/5000K
LED binning	s-line: 2.5-step MacAdam ellipse k-line: 3-step MacAdam ellipse
CRI	≥95
Lifetime	50,000 hours @ 25°C (50,000 hours @ 77°F)
Operating temp	T _a = -25 to 50°C (T _c max = 76°C) T _a = -13 to 122°F (T _c max = 169°F)
IP Rating	IP40
Finish	Silver anodised
Mounting	Surface mounting via concealed clips
Power feed	Hardwire tails or male/female connectors
Control	0-10V/1-10V/DMX/DALI



LED Grading Key

Exclusive Grade

s s-line*	*KKDC tuned CCT range
2.5-step CCT range	

Base Grade

k k-line	3-step commercial range
	Energy Star CCTs

Power consumption	Supply voltage	Supply current
16W/m (4.88W/ft)	24V DC	0.67A/m (0.20A/ft)

Performance Data (2100K+5000K)

	R1	R2	R3	R4	R5	R6	R7	R8	R9	R10	R11	R12	R13	R14
k-line	96	96	97	97	97	92	94	94	91	94	96	78	96	99

	Clear Cover	Diffused Cover	CRI	R9	Rf	Rg
s-line	1323lm/m (403lm/ft) 82.7lm/W	984lm/m (300lm/ft) 61.5lm/W	96	92	-	-
k-line	1243lm/m (379lm/ft) 78lm/W	934lm/m (285lm/ft) 58lm/W	95	91	-	-

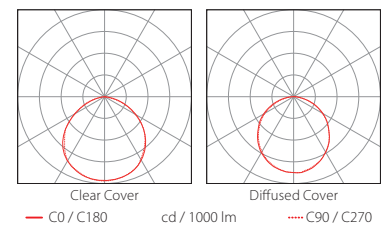
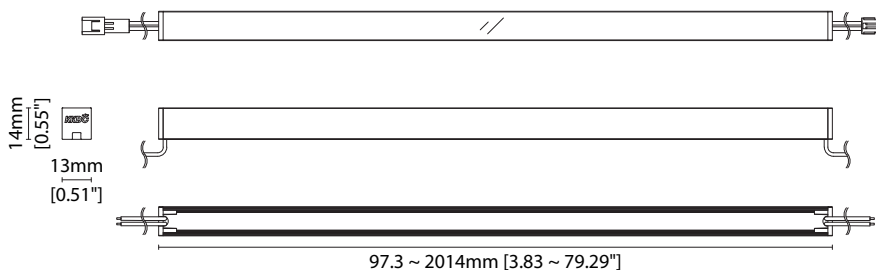

Data derived from independent UKAS/IESNA LM-79-08 accredited testing of production samples.

FIXTURE

Model	Finish ¹	Cover ²	Grade ³	LED	Colour (CCT)	Length Availability ⁴	IP	Cable Length	Power Feed ⁵	Input																			
LINE-S	LS	Silver Anodised (grey endcaps)	SA	Clear B	R207	R207	1900K	19	m	97.3-2014mm 83.3mm increments	IP40	40	50mm/1.97"	0050	Single no sheath tail	S00X	DC 24V	g											
																			Silver Anodised (white endcaps)	SAWE	Diffused C	s	k	2100K	21	i	3.83-79.29in 3.28in increments	(Specify length code OR total run length)	300mm/11.81"
	2300K	23	2500K	25	2700K	27	3000K	30	3500K	35	4000K	40	5000K	50															
															S	k	2100K+5000K	513.8mm											

¹ Refer to **End Cap Options** on **Options** pages

² Refer to **Cover/Lens Options** on **Options** page

³ Refer to **LED Grading Key** on **Specification sheet** page

⁴ Refer to **Length Availability List** or enter total run length instead of length code

⁵ Refer to **Power Feed Options** on **Options** pages

⁶ LEDmix requires two colour temperature choices

Code Example:

LS	-	SA	-	C	-	s	-	R207	-	2150	-	m	-	514	-	40	-	0300	-	D00X	-	g
LINE-S		Silver Anodised (grey endcaps)		Diffused				R207		2100K+5000K		513.8mm		IP40		300mm/11.81"		Double no sheath tail		DC 24V		

ACCESSORIES

Mounting Accessories

KKCP-10 Concealed Clip

* Refer to **Mounting accessories** on **Accessories** pages

Connection Accessories

KKCN-18 4 PIN LEDmix male & female 50mm (1.97in) pair

KKCN-19 4 PIN LEDmix male & female 300mm (11.81in) pair

KKCN-24 4 PIN LEDmix 300mm (11.81in) extension lead

* Refer to **Power feed** on **Accessories** pages

PSU/Driver

0-10V/1-10V/DALI/DMX

* Refer to **Driver/PSU Options** page for details or provide requirement and KKDC to offer the suitable option

LED ENGINE VARIANTS (LED STRIP TYPE)

Colour	LED	Lumen/m	Lumen/ft	W/m	W/ft	Spec Doc	Length	Increment
Single CCT	R007	564	172	7	2.13	LINE-S R007	97-2014mm (3.81-79.29in)	41.7mm (1.64in)
	R014	1158	353	14	4.27	LINE-S R014	97-2014mm (3.81-79.29in)	41.7mm (1.64in)
	R020	1632	498	20	6.10	LINE-S R020	97-2014mm (3.81-79.29in)	41.7mm (1.64in)
Warm Dim/Dynamic White	R207	1323	403	16	4.88	LINE-S R207	97-2014mm (3.81-79.29in)	83.3mm (3.28in)
RGB	501	Red 134 Green 284 Blue 46 RGB 423	Red 41 Green 87 Blue 14 RGB 129	15.6	4.75	LINE-S RGB	97-2014mm (3.81-79.29in)	83.3mm (3.28in)

* Performance data: s-line, clear cover, 2100K + 5000K

LINI-S R207

Length Availability List

Length Code		Fixture Length ¹		LED Strip ²		End Cap Dimension		Wattage (W)	Output (lm)
Metric	Imperial(US)	Metric	Imperial(US)	Metric	Imperial(US)	Metric	Imperial(US)		3000K (Test Data)
m0097	i0004	97mm	3.83in	83mm	3.28in	4mm	0.16in	1.33	87
m0181	i0007	181mm	7.11in	167mm	6.56in	4mm	0.16in	2.67	173
m0264	i0010	264mm	10.39in	250mm	9.84in	4mm	0.16in	4.00	260
m0347	i0014	347mm	13.67in	333mm	13.12in	4mm	0.16in	5.33	347
m0431	i0017	431mm	16.96in	417mm	16.40in	4mm	0.16in	6.67	433
m0514	i0020	514mm	20.24in	500mm	19.69in	4mm	0.16in	8.00	520
m0597	i0024	597mm	23.52in	583mm	22.97in	4mm	0.16in	9.33	607
m0681	i0027	681mm	26.80in	667mm	26.25in	4mm	0.16in	10.67	693
m0764	i0030	764mm	30.08in	750mm	29.53in	4mm	0.16in	12.00	780
m0847	i0033	847mm	33.36in	833mm	32.81in	4mm	0.16in	13.33	867
m0931	i0037	931mm	36.64in	917mm	36.09in	4mm	0.16in	14.67	953
m1014	i0040	1014mm	39.92in	1000mm	39.37in	4mm	0.16in	16.00	1040
m1097	i0043	1097mm	43.20in	1083mm	42.65in	4mm	0.16in	17.33	1127
m1181	i0046	1181mm	46.48in	1167mm	45.93in	4mm	0.16in	18.67	1213
m1264	i0050	1264mm	49.76in	1250mm	49.21in	4mm	0.16in	20.00	1300
m1347	i0053	1347mm	53.04in	1333mm	52.49in	4mm	0.16in	21.33	1387
m1431	i0056	1431mm	56.33in	1417mm	55.77in	4mm	0.16in	22.67	1473
m1514	i0060	1514mm	59.61in	1500mm	59.06in	4mm	0.16in	24.00	1560
m1597	i0063	1597mm	62.89in	1583mm	62.34in	4mm	0.16in	25.33	1647
m1681	i0066	1681mm	66.17in	1667mm	65.62in	4mm	0.16in	26.67	1733
m1764	i0069	1764mm	69.45in	1750mm	68.90in	4mm	0.16in	28.00	1820
m1847	i0073	1847mm	72.73in	1833mm	72.18in	4mm	0.16in	29.33	1907
m1931	i0076	1931mm	76.01in	1917mm	75.46in	4mm	0.16in	30.67	1993
m2014	i0079	2014mm	79.29in	2000mm	78.74in	4mm	0.16in	32.00	2080

¹ Actual total overall length of light fixture (LED strip + end caps + void/wire hole)

² Actual length of PCB strip

³ Actual length of 2x end caps

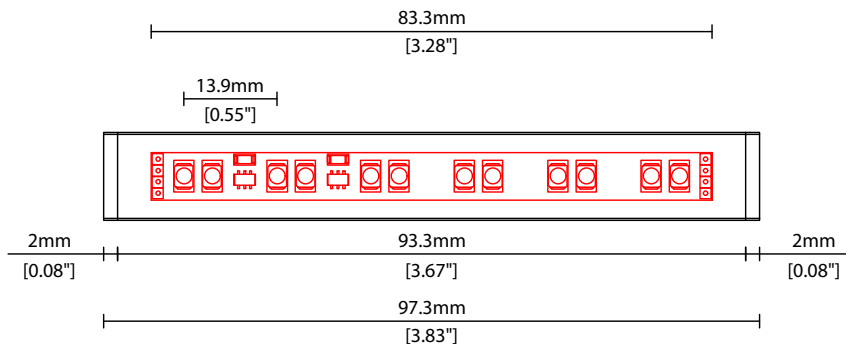

Linear

LINI-S R207

Options

KKDC

COVER/LENS OPTIONS

* Options are an integral part of the fixture ordering codes. Please refer to **Code Table** pages.

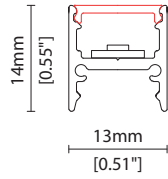

B Clear cover
W13/H14(W0.51/H0.55in)

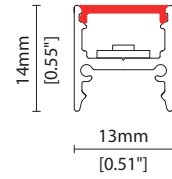

C Diffused cover
W13/H14(W0.51/H0.55in)

END CAP OPTIONS



SA Silver anodised finish
with grey end caps.

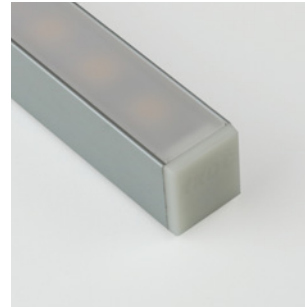

SAWE Silver anodised finish
with white end caps.

POWER FEED OPTIONS

0050 S20X 50mm (1.97") Single no sheath IP20 connector

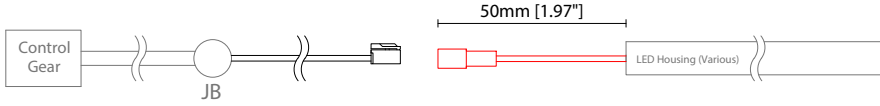

0050 D20X 50mm (1.97") Double no sheath IP20 connector

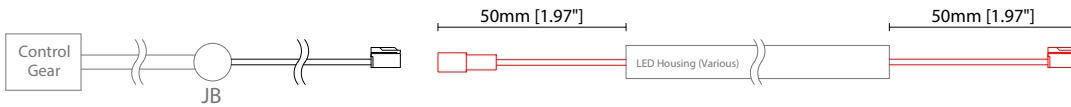

0300 S00X 300mm (11.81") Single no sheath tail

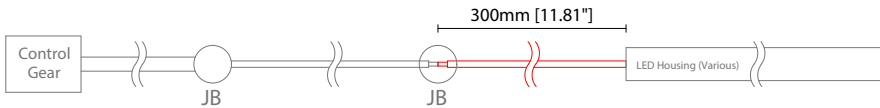

0300 D00X 300mm (11.81") Double no sheath tail

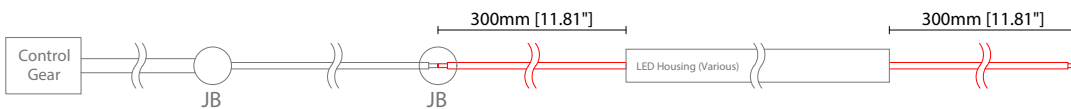

0300 S20X 300mm (11.81") Single no sheath IP20 connector

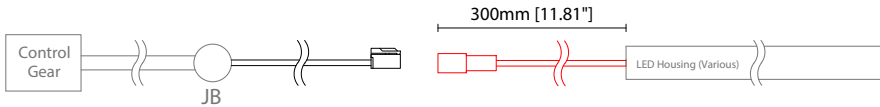

0300 D20X 300mm (11.81") Double no sheath IP20 connector

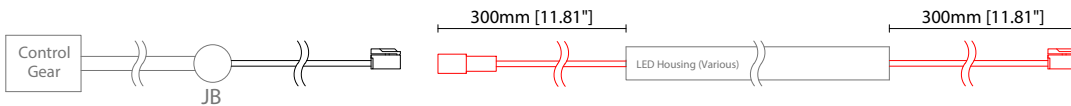

1000 S00X 1000mm (39.37") Single no sheath tail

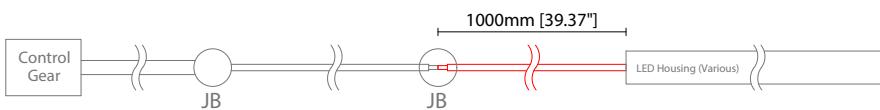

1000 D00X 1000mm (39.37") Double no sheath tail

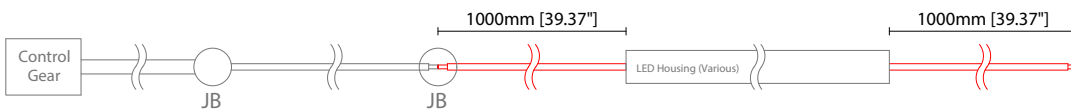

1000 S20X 1000mm (39.37") Single no sheath IP20 connector

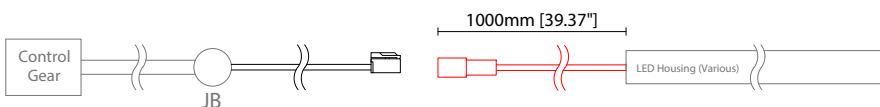

Key

Control Gear Power supply, sub-controllers & control systems

JB Junction box / cable connection

POWER FEED OPTIONS (CONTINUED)

1000 D20X 1000mm (39.37") Double no sheath IP20 connector

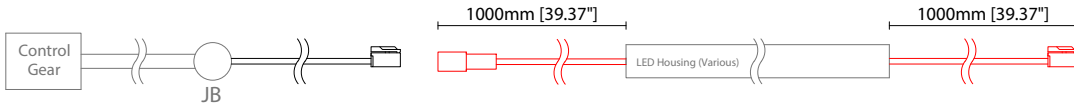

4 Pin LEDmix Female Connector

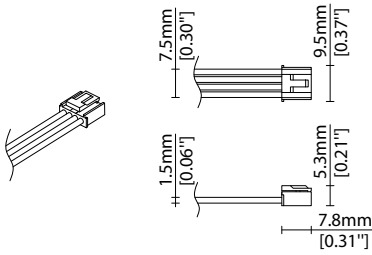

4 Pin LEDmix Male Connector

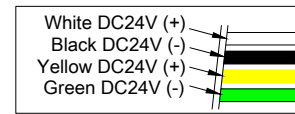
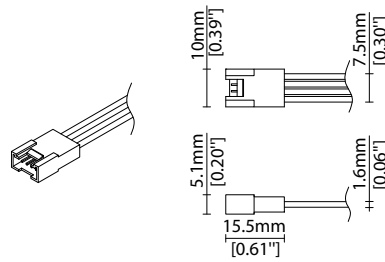

Key

Control Gear Power supply, sub-controllers & control systems
 JB Junction box / cable connection

MOUNTING ACCESSORIES

Note: Accessories are to be ordered separately with corresponding code shown below.

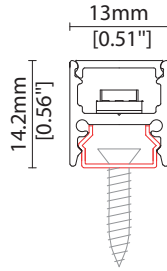

KKCP-10

Concealed clip
(allow 3 per metre/40in)
S/Steel finish
L20/W13/H14.2mm
(L0.79/W0.51/H0.56")

POWER FEED

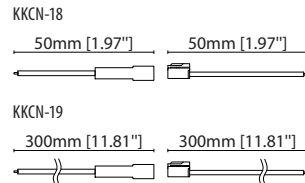

KKCN-18 50mm (1.97in) pair
KKCN-19 300mm (11.81in) pair
4 PIN LEDmix male + female
connector set

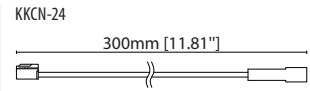

KKCN-24

4 PIN LEDmix 300mm (11.81in)
extension lead

KKDC CONTROL



IP20
Plastic housing
L170/W59/H29mm
(L6.69/W2.32/H1.14in)

KKDM-06 1-10V

visDIM dimmable sub-controller
(4 x 8A max @ 12-36V)



IP20
Plastic housing
L170/W53.4/H28mm
(L6.69/W2.10/H1.10in)

KKSC-05 DMX

visDIM dimmable sub-controller
(4 x 5A max @ 12-36V)

Linear

LINE-S R207

Accessories

KKDC

KKDC CONTROL (CONTINUED)



IP20
Plastic housing
L170/W59/H29mm
(L6.69/W2.32/H1.14in)

KKDL-02 DALI

visDIM dimmable sub-controller
(4 x 8A max @ 12-36V)



IP20
Plastic housing
L166/W53.4/H23mm
(L6.54/W2.10/H0.91in)

KKDL-03 DALI

visDIM dimmable sub-controller
(4 x 5A max @ 12-36V)

AVAILABLE PSU OPTIONS

Control Mode	PSU (Order Code)	Input Voltage AC	Output Voltage DC	Rated Output Current	Rated Power	Dim %	IP Rating
Switched	CEN-60-24	90-295V	24V	2.5A	60W	-	IP67
	HLG-60H-24	90-305V	24V	2.5A	60W	-	IP67
	HLG-100H-24	90-305V	24V	4.0A	100W	-	IP67
	HLG-150H-24	90-305V	24V	6.3A	150W	-	IP67
	HLG-240H-24	90-305V	24V	10A	240W	-	IP67
0-10V (1-10V)	PWM-40-24	90-305V	24V	1.67A	40W	100-0.15 (100-10)	IP67
	PWM-60-24	90-305V	24V	2.5A	60W	100-0.15 (100-10)	IP67
	PWM-90-24	90-305V	24V	3.67A	90W	100-0.15 (100-10)	IP67
	PWM-120-24	90-305V	24V	5.0A	120W	100-0.15 (100-10)	IP67
DALI	LIN100A1	120-277V	24V	1A per channel	100W	100-0.1	IP66/IP40
DMX RGB	LIN100A1	120-277V	24V	1.33A per channel	100W	100-0.1	IP66/IP40
DMX RGBW	LIN100A1	120-277A	24V	1A per channel	100W	100-0.1	IP66/IP40

Flicker Free Options - Combination of PSU+ sub-controller

Control Mode	PSU (Order Code)	Sub-controller (Order Code)	Input Voltage AC	Output Voltage DC	Rated Output Current	Rated Power	Dim %	IP Rating PSU/ Sub-controller
0-10V or 1-10V	CEN-60-24	KKDM-06	90-295V	24V	2.5A	60W	100-0.9	IP67/IP20
	HLG-60H-24	KKDM-06	90-295V	24V	2.5A	60W	100-0.9	IP67/IP20
	HLG-100H-24	KKDM-06	90-295V	24V	4.0A	100W	100-0.9	IP67/IP20
	HLG-150H-24	KKDM-06	90-295V	24V	6.3A	150W	100-0.9	IP67/IP20
	HLG-240H-24	KKDM-06	90-295V	24V	10.0A	240W	100-0.9	IP67/IP20
DALI	CEN-60-24	KKDL-02/03	90-295V	24V	2.5A	60W	100-0.1	IP67/IP20
	HLG-60H-24	KKDL-02/03	90-305V	24V	2.5A	60W	100-0.1	IP67/IP20
	HLG-100H-24	KKDL-02/03	90-305V	24V	4.0A	100W	100-0.1	IP67/IP20
	HLG-150H-24	KKDL-02/03	90-305V	24V	6.3A	150W	100-0.1	IP67/IP20
	HLG-240H-24	KKDL-02/03	90-305V	24V	10.0A	240W	100-0.1	IP67/IP20
DMX RGB	CEN-60-24	KKSC-05	90-295V	24V	2.5A	60W	100-0.9	IP67/IP20
	HLG-60H-24	KKSC-05	90-305V	24V	2.5A	60W	100-0.9	IP67/IP20
	HLG-100H-24	KKSC-05	90-305V	24V	4A	100W	100-0.9	IP67/IP20
	HLG-150H-24	KKSC-05	90-305V	24V	6.3A	150W	100-0.9	IP67/IP20
	HLG-240H-24	KKSC-05	90-305V	24V	10.0A	240W	100-0.9	IP67/IP20

¹ The items shown above cover the most frequently used specification but does not exhaust the possible options

² PSU and/or driver can be chosen from the table, or KKDC may recommend the best option upon receipt of the controls requirement and installation environment

³ Electrical shop drawing will include detailed information of PSU and relevant control drivers

⁴ Cut sheets are available on the controls section of www.kkdc.lighting or upon request